

MICROBORE HOSE, ASSEMBLIES & ACCESSORIES

- 
- **Dn2 & Dn4 hose in a range of materials**
 - **Working pressures up to 630 bar**
 - **Wide selection of hose end fittings & thread types from stock**
 - **Standard steel and stainless steel options**
 - **Hose assemblies manufactured to any length and most configurations from stock in the UK**

Hydrotechnik UK have been supplying microbore hoses for pressure testing applications for over 25 years. Our assemblies are for DN2 and DN4 microbore hoses and work with different pressures e.g. 315 bar, 400 bar or 630 bar. We are able to supply microbore hose assemblies to almost any configuration from stock and aim to offer same day despatch wherever possible if required.

R & D

Mobile hydraulics

End of Line Testing

Plant maintenance

Industrial hydraulics

DN2 and DN4 High pressure Microbore hose Technical data

Microbore hose

The microbore hose assembly, most commonly used to connect to a Minimes® test point for pressure testing, has many other diverse applications. The hose is available in 2mm and 4mm internal diameter up to 630 bar working pressure. The hose material is extremely flexible, light weight and can be specified for a large range of uses:

- Oils
- Water
- Bleeding
- Gases
- Sampling
- Aggressive media
- Grease
- Permanent installations
- Pressure testing up to 630 bar

Technical data

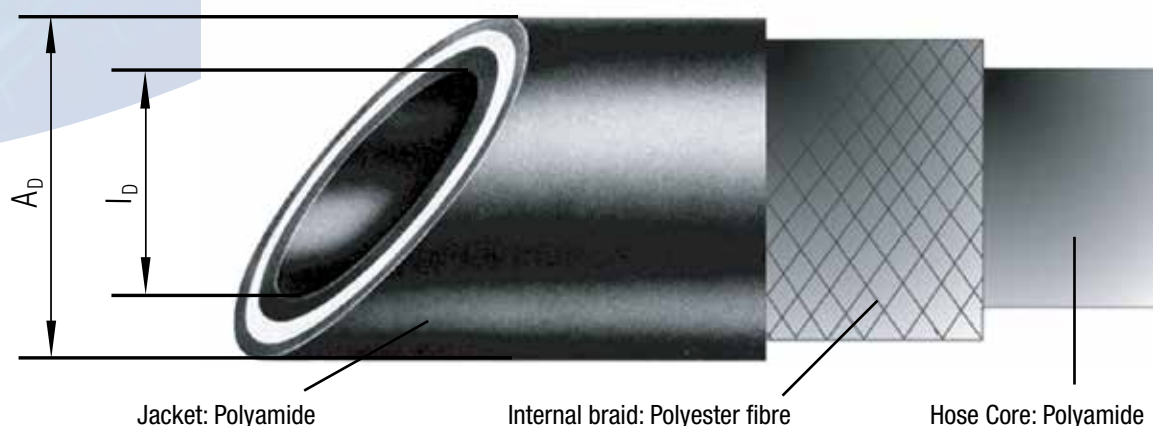

Width Nominal	Design	Application	Max working Bar	pB Bar	Id mm	Ad mm	Min. Bend radius	Temperature range	Pressure utilisation factor
DN2	Standard 400	Perforated hose	400	1040	2	5	20 (below -20°C 30mm)	-20°C up to +100°C short time up to +120°C	0°C 122% 30°C 110% 50°C 100% 80°C 86% 100°C 77% 120°C 68%
DN2	Standard 630	Perforated hose	630	1950	2	5		-54°C up to +100°C	Example for calculation: MINIMESS®-hose DN 2/630 Bar at 30°C pressure utilisation factor: 630 x 1.10 = 693 Bar
DN2	Low temperature	Perforated hose	630	1950	2	5			
DN5	Standard 315	Perforated hose	315	810	4	8	40 (below -20°C 60)	-20°C up to +100°C short time up to +120°C	
DN4	Standard 450	Perforated hose	450	1500	4	8			

Reference of the specified data: 20°C – 3 K

- pn = operating pressure
 pB = bursting pressure
 ID = internal diameter
 AD = external diameter
 rmin = Minimum bend radius of hose
 Perforated hose = Jacket of hose is perforated for applications using gas

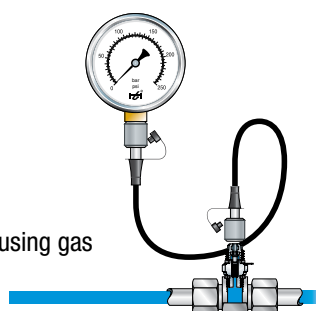

20mm bend radius!



Definition for the tightness of a MINIMESS - hose pipe

"Technically tight" describes systems, part systems and functional elements if the leakage rate amounts to < 0.00001 mbar l s-1.

Criteria for selection of hoses and fittings

- Selection of the hose assembly for the maximum operating pressure (pn):
 When ordering a hose assembly, please pay attention to the operating pressures of both the hose material and the connection fitting. The lowest pressure determines the max. operating pressure of the complete hose assembly.
- Selection of hose assembly for use with different media:
 Hose assemblies can be used with different media, as long as the end connections are suitable. To check the compatibility for different media, please contact us.



DN2 and DN4 High pressure Microbore hose Technical data

Pressure loss data of hose & hose assembly with 1620 female and fitting:

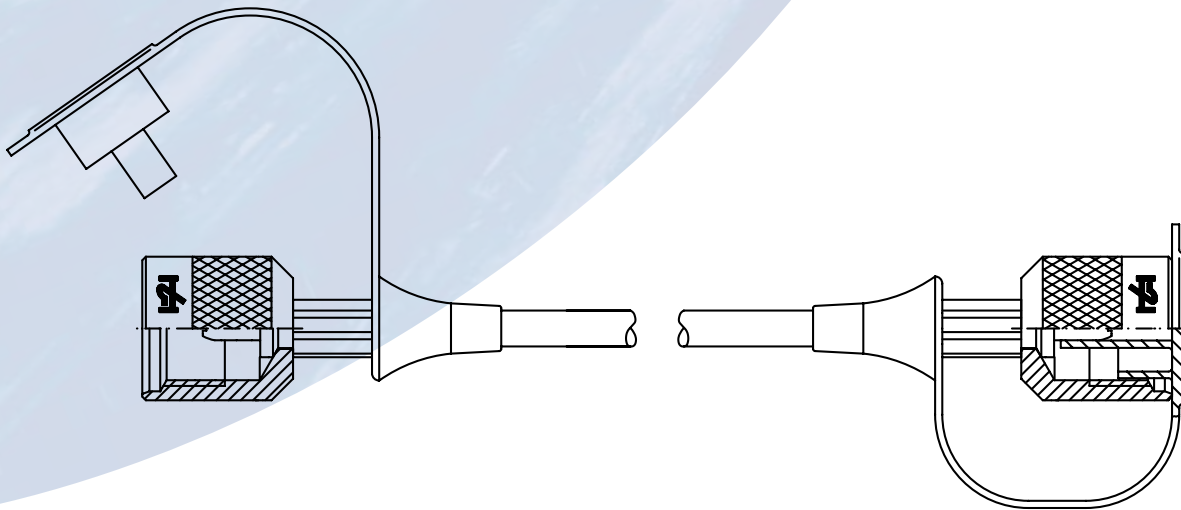

Safety note: The hose assemblies have to be protected from flames and sharp-edged, hot objects.

Pressure loss curve of DN 2 hose only

Pressure loss in Bar per metre of hose length without fittings, mineral oil: viscosity 30mm² s⁻¹

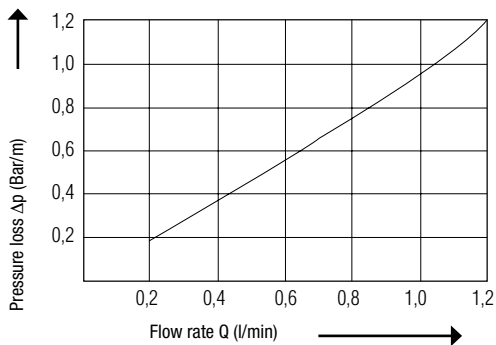

Pressure loss curve of DN 2 hose assemblies

Pressure loss in Bar through a hose assembly with a length of 1 m, with fittings and Test Points of series 1620 on both sides, mineral oil: viscosity 30mm² s⁻¹

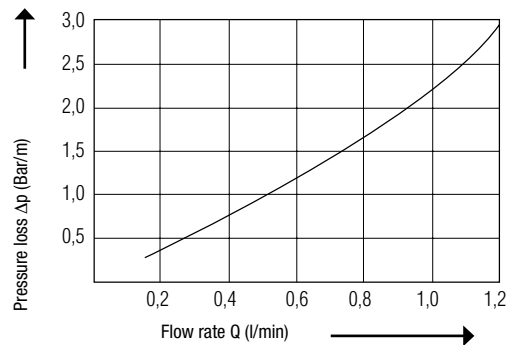

Pressure loss curve of DN 4 hoses

Pressure loss in Bar per metre of hose length without fittings, mineral oil: viscosity 30mm² s⁻¹

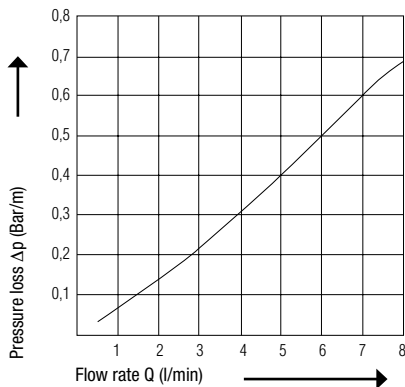

Pressure loss curve of DN 4 hose pipes

Pressure loss in Bar through a hose assembly with a length of 1 m, with fittings and test points of series 1604 on both sides, mineral oil: viscosity 30mm² s⁻¹

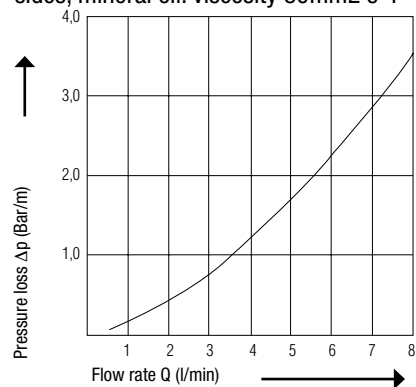

We guarantee a very high quality level of our MINIMESS® systems, as all components are manufactured very precisely and to tight tolerances. All parts in our MINIMESS® systems are easy and safe to use. We reserve the right to carry out technical modifications!

Hose material DN 2 and DN 4



Hose material for self assembly		Part number
Perforated hose, DN 2	400 Bar	2020-01-00.31
Perforated hose, DN 2	630 Bar	2020-01-00.30
Low temperature, Perforated hose, DN 2	630 Bar	2020-01-00.18

Perforated hose, DN 4	315 Bar	2030-01-00.22
Perforated hose, DN 4	450 Bar	2030-01-00.24

Anti-buckling spiral

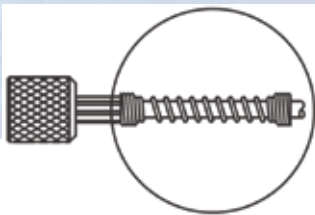

Anti-buckling spiral for self assembly		Part number
Anti-buckling spiral for DN 2		2123-01-00.01
Anti-buckling spiral for DN 4		2133-01-00.01

Aluminium protection braid

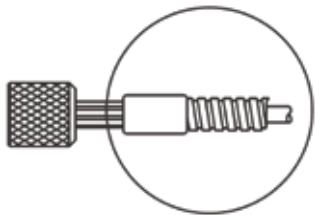

Aluminium protection hose for self assembly		Part number
Aluminium protection hose DN 2 In addition to this, 2 pieces end screw sockets are necessary		2121-01-00.01
End screw sockets DN 2		2121-01-00.02

Aluminium protection hose for self assembly		Part number
Aluminium protection hose DN 4 In addition to this, 2 pieces end screw sockets are necessary		2131-01-00.01
End screw sockets DN 4		2131-01-00.02

Over braiding

Hydrotechnik UK can offer a hose braiding service for all hose materials in Nylon, soft stainless steel and many other materials on request. Over braiding offers further structural and aesthetic advantages.



Over braided microbore hose

Other accessories

- Coloured heat shrink jackets
- Hose identification tags
- Customer branded labels
- Hose pressure testing and certification





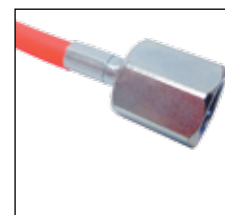



Anti-buckle springs

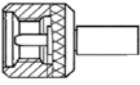
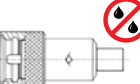

Hose tagging & sleeving

DN2 & DN4 MICROBORE HOSE ASSEMBLIES



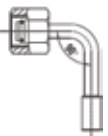





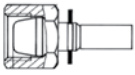

Hose end ordering tables

Picture	Description	Hose code	DN2	DN4
	1215 swivel female with knurled nut 1615 swivel female with knurled nut 1620 swivel female with knurled nut 1604 swivel female with knurled nut HSP (5/8"BSF) swivel female with o-ring & backing ring	AA AB AC AD HSP	✓ ✓ ✓ ✓ x ✓	✓ ✓ ✓ ✓ x
	1215 swivel female with in built check valve 1615 swivel female with in built check valve 1620 swivel female with in built check valve 1604 swivel female with in built check valve	AP AQ AR AY	✓ ✓ ✓ x	x x ✓ ✓
	1215 swivel female 90° compact hex nut 1615 swivel female 90° compact hex nut 1620 swivel female 90° compact hex nut	AJ AK AL	✓ ✓ ✓	x x x
	Steck plug-in test port	AI	✓	x
	ISO228-G1/4" BSP swivel female gauge ISO228-G1/2" BSP swivel female gauge	FA FB	✓ ✓	✓ x
	ISO228-G1/4" BSP swivel female gauge 90° swept ISO228-G1/2" BSP swivel female gauge 90° swept	FC FD	✓ ✓	x x
	M12 x 1.5 (6L) Swivel Female 24° Sealing cone M14 x 1.5 (8L) Swivel Female 24° Sealing cone M16 x 1.5 (10L) Swivel Female 24° Sealing cone M18 x 1.5 (12L) Swivel Female 24° Sealing cone M14 x 1.5 (6S) Swivel Female 24° Sealing cone M16 x 1.5 (8S) Swivel Female 24° Sealing cone M18 x 1.5 (10S) Swivel Female 24° Sealing cone M20 x 1.5 (12S) Swivel Female 24° Sealing cone	CQ CR CS CT CU CV CW CX	✓ ✓ ✓ ✓ ✓ ✓ ✓ ✓ ✓	✓ ✓ ✓ ✓ ✓ ✓ ✓ ✓
	M12 x 1.5 (6L) Swivel Female 24° Sealing cone 90° Swept M14 x 1.5 (8L) Swivel Female 24° Sealing cone 90° Swept M16 x 1.5 (10L) Swivel Female 24° Sealing cone 90° Swept M18 x 1.5 (12L) Swivel Female 24° Sealing cone 90° Swept M14 x 1.5 (6S) Swivel Female 24° Sealing cone 90° Swept M16 x 1.5 (8S) Swivel Female 24° Sealing cone 90° Swept M18 x 1.5 (10S) Swivel Female 24° Sealing cone 90° Swept M20 x 1.5 (12S) Swivel Female 24° Sealing cone 90° Swept	DA DB DC DD DE DF DG DH	✓ ✓ ✓ ✓ ✓ ✓ ✓ ✓	✓ ✓ ✓ ✓ ✓ ✓ ✓ ✓

For stainless steel ends or for ends not listed, please contact us.





DN2 & DN4 MICROBORE HOSE ASSEMBLIES

Hose end ordering tables

Picture	Description	Hose code	DN2	DN4
	4mm Standpipe 6mm Standpipe 8mm Standpipe 1/4" Standpipe	BA BB BC BD	✓ ✓ ✓ ✓	✓ ✓ ✓ ✓
	6mm Standpipe 90° Swept	BG	✓ ✓ ✓	✓ ✓ ✓
	1/8" BSP swivel female 60° cone seal 1/4" BSP swivel female 60° cone seal 3/8" BSP swivel female 60° cone seal	FF DI EI	✓ ✓ x	✓ ✓ ✓
	1/4" BSP swivel female 60° cone seal 90° swept elbow	DY	✓	✓
	1/8" BSP fixed male 60° cone seal 1/4" BSP fixed male 60° cone seal	FM DM	✓ ✓	x ✓
	1/8" NPT fixed female 1/4" NPT fixed female	PF PI	✓ ✓	x ✓
	1/8" NPT fixed male 1/4" NPT fixed male	PA PB	✓ ✓	✓ x
	1/2 - 20" JIC Swivel female 37° Cone seal 7/16 - 20" JIC Swivel Female 37° Cone seal	MJ MK	✓ ✓	✓ x
	9/16 - 18" UNF swivel female ORFS 11/16 - 16" UNF swivel female ORFS	BM HC	✓ ✓	x x
	Banjo to suit M8 x 1 bolt Banjo to suit M10 x 1 bolt Banjo to suit 1/8" BSP bolt	ID IB IF	✓ ✓ ✓	✓ ✓ ✓
	Banjo c/w 8mm bolt Banjo c/w 10mm bolt Banjo c/w 1/8" BSP bolt	IC IA IE	✓ ✓ ✓	✓ ✓ ✓

For stainless steel ends or for ends not listed, please contact us.

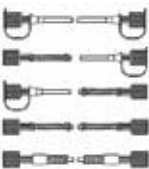
DN2 & DN4 hose assembly ordering chart

Options		Part number			
		S	X	X	X
Material of the fittings		↓	↓	↓	↓
Zinc Nickle Plated Carbon Steel		1			
Stainless Steel 1.4571 (316Ti) Grade. Contact us for availability		7			
DN2 hose options					
Perforated standard hose (400 bar)		↓			
Perforated standard hose (630 bar)		0			
Perforated low temperature hose (630 bar)		1			
PTFE Bore, stainless braided hose (450 bar)		2			
DN4 hose options					
Perforated standard hose (315 bar)			5		
Perforated standard hose (450 bar)			6		
Accessories					
Standard			↓		
Anti buckling spring, left side (min. hose length 40 cm)		0			
Anti-buckling spring, right side (min. hose length 40 cm)		1			
Anti-buckling spring both sides (min. hose length 40 cm)		2			
Aluminium protection hose (min. hose length 40 cm)		3			
Hose ends & hose length					
Hose end code 1			↓		
Hose end code 2			↓		
Length L in cm (e.g. 30 cm = 00.30 or 500 cm = 05.00) Input as a 4-digit group of figures			↓		↓

Please note: Aluminium overbraid can not be used in conjunction with anti buckle springs

Ordering example: S110-AC-FA-00.63

DN2 (630bar) hose assembly with 1620 female hose end to G1/4" BSP female gauge hose end, 630mm (63cm) long.

Stainless steel wire-braided PTFE bore Microbore hose

Hydrotechnik UK can now offer microbore hose with a stainless steel wire braid & PTFE inner tube. With a large temperature range and rugged construction, this hose will stand up to the harshest of operating conditions. Suitable for most fluids. There are 2 options - High pressure and low pressure hoses.

Specifications

HIGH PRESSURE	DN2
Internal diameter	2mm
External diameter	5mm
Max working pressure	450 bar
Min Bend Radius	13 mm
Temperature range (pressure dependant over 130°C)	-70°C to 260°C

LOW PRESSURE	DN2	DN4
Internal diameter	2mm	4 mm
External diameter	5mm	8 mm
Max working pressure	100 bar	100 bar
Min Bend Radius	20 mm	35 mm
Temperature range (pressure dependant over 130°C)	-70°C to 260°C	-70°C to 260°C

Please use hose code **9** in table above for this hose option e.g **S190-AS-FA-00.63**

Please use hose codes - DN2 **S19S-FF-FF-00.55**
DN4 **S1AS-FF-FF-00.55**



Installation of microbore hose assemblies

Correct operation & long life is dependent upon the correct installation. Please see below:-

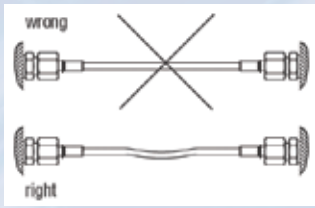

Under load, the length of a hose pipe can change. A shortening causes an additional tensile stress of the hose and the connections. Therefore, the hose pipe needs “slack” in an unpressurised state. Please tighten the union nuts only so far using recommended tightening torques. Further tightening does not improve the operation and can damage the connections.

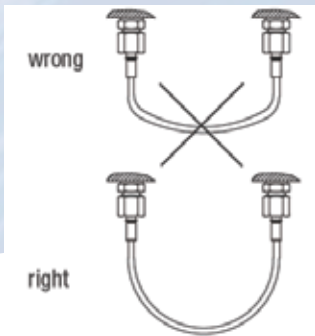

With curved assemblies, attention has to be paid to the bending radius. Sharp bends should be avoided wherever possible. When calculating the length of a hose assembly, please to pay attention to the fact that the connection fittings are not flexible. The correct calculation of the free hose length between the fittings is therefore essential.

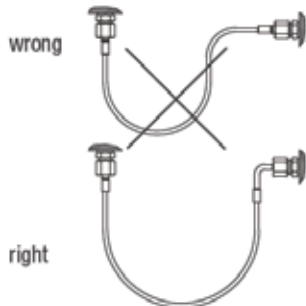

90° hose fittings are also available to aid in the fitting of hose assemblies to maximize life and operation of the assembly.

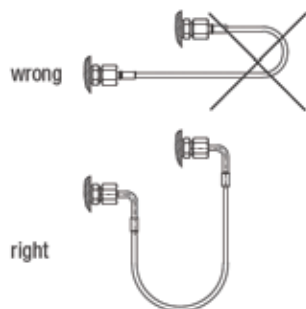

90° hose fittings can also aid in the fitting of a tidy hose assembly in the tightest of porting requirements.

Notes for operation and installation

In order to guarantee the operability of hoses and to not reduce assembly life by introducing additional strains, the following points have to be taken into consideration:

- Hose assemblies may not be strained during operation by external influences like tension, torsion and upset.
- The smallest mentioned bending radius of the hose must not be exceeded at any time.
- Hose assemblies have to be protected against external damages caused by thermal, chemical or mechanical influences.
- Painting or marking of hose assemblies should be avoided.

Notes for storage of hose and hose assemblies

- Store in cool, dry places and avoid direct UV-irradiation.
- Sources of radiant heat should be avoided.
- Ozone building light fittings and electronic instruments with sparking should be kept away from hoses and hose material (e.g. mercury vapour discharge lamps)
- Optimum storage conditions are temperatures between +15°C and +25°C, a relative air humidity of 65%, as well as shielding against UV-radiation by special UV-impervious foils.
- The storage time should not exceed four years for hose and two years for hose assemblies.